

SECTION 1A

ENGINE MOUNT OIL RESERVOIR THROTTLE



Rotax aircraft engines are manufactured and supported by Rotax GmbH of Austria. Read and understand the Rotax manuals completely before starting with the engine installation, as they contain important engine installation, operation and maintenance information. Follow all of the important safety information provided in the Rotax manuals regarding the installation, operation and maintenance of the Rotax engine. Read and understand the Rotax Operator's Manual before starting the engine.

Make sure that your engine is registered with Rotax or an authorized distributor so that the factory warranty is in effect. In the United States, the Rotax distributor is Kodiak Research: <http://www.kodiakbs.com> Contact a Rotax distribution or service partner if you do not understand the instructions or if you have any additional questions. Maintain copies the manuals with the aircraft in case of sale. Obtain current versions of the manuals from the official Rotax website, as well as current service and maintenance information: www.rotax-aircraft-engines.com

If a discrepancy arises between the information provided by Rotax and the following pages, the Rotax manuals and/or service information and instructions take precedence. Zenith Aircraft Company does not manufacture or directly support engines.

Alternative engines will affect performance, specifications and flight characteristics of the aircraft. Also, the weight and balance of the aircraft may be adversely affected by alternative engines, and the original fuel system may not be adequate or suitable for some engines. Most alternative engines will require a custom engine mount and engine cowl.

ENGINE MOUNT

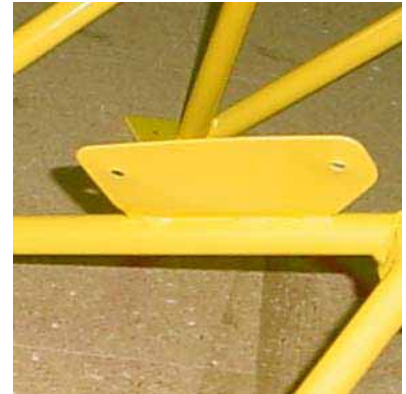
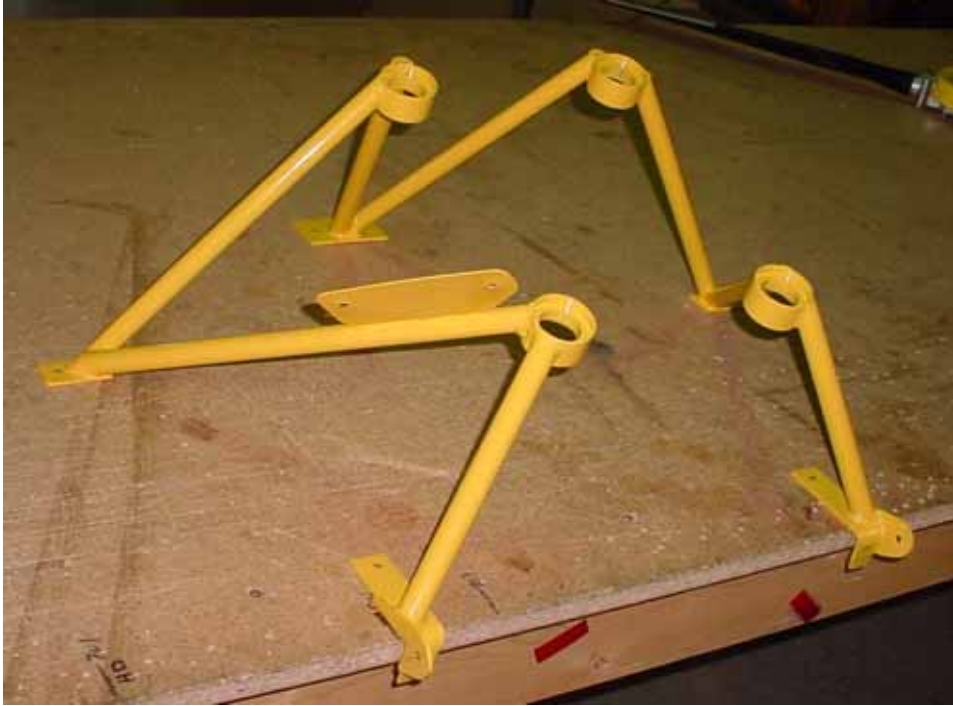

912S-EM Engine mount for Rotax ring mount.



Check that the front flange of the upper channel 7F7-1SP does not touch the engine mount. If necessary, file a relief in the flange.

Position the engine mount on the firewall.

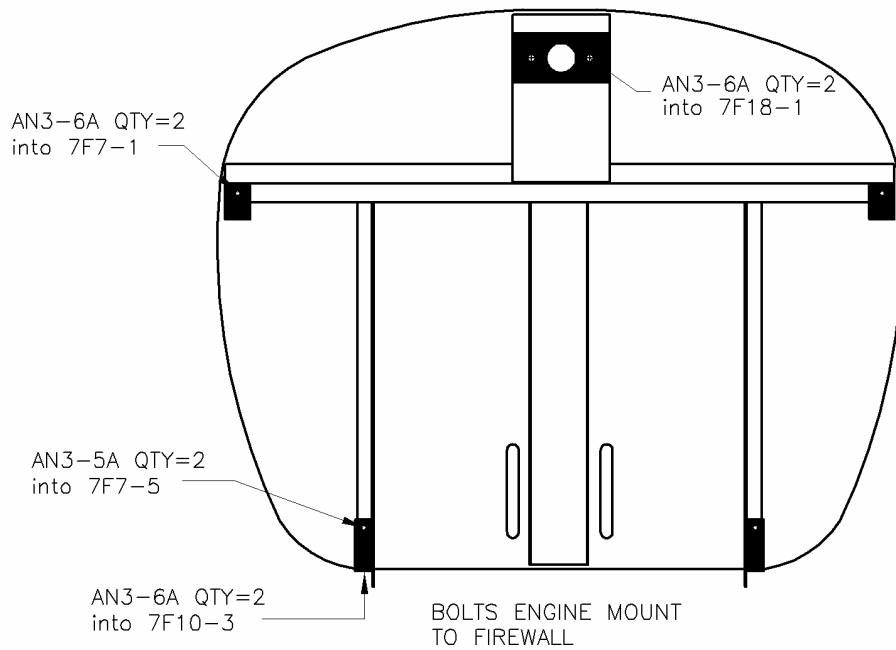

Float fitting welded to the side of the lower bracket.

Drawing 7-E-1
Firewall foot print for the engine mount and bolts.



Check that the inside edge of the bottom flange does not touch the vertical flange on the longeron. If necessary trim the steel bracket. Do not cut the extrusion 7F10-3.



Lower bracket. The bottom flange overlaps the front bottom longeron 7F10-3. Make sure there is no gap between the bottom flange and the longeron.



The upper holes are drilled through the firewall and into the cabin frame 7F18-1.

AN3-6A Upper bolts.
SUGGESTION: First drill pilot holes and cleco the engine mount to the firewall.



Nylon self locking nut on the cabin side of the firewall.

Cabin side view of the firewall and the welded steel plate at the end of the cabin frame 7F18-1.



Left middle attachment.

AN3-6A

SHIM: It is normal for the steel plate on the engine mount to partially overlap the firewall wall flange of the upper channel 7F7-1SP. If necessary, add a .063" shim between the plate and the firewall. Also see cross section B-B on drawing 7-F-14 (above part number 7F14-6R).

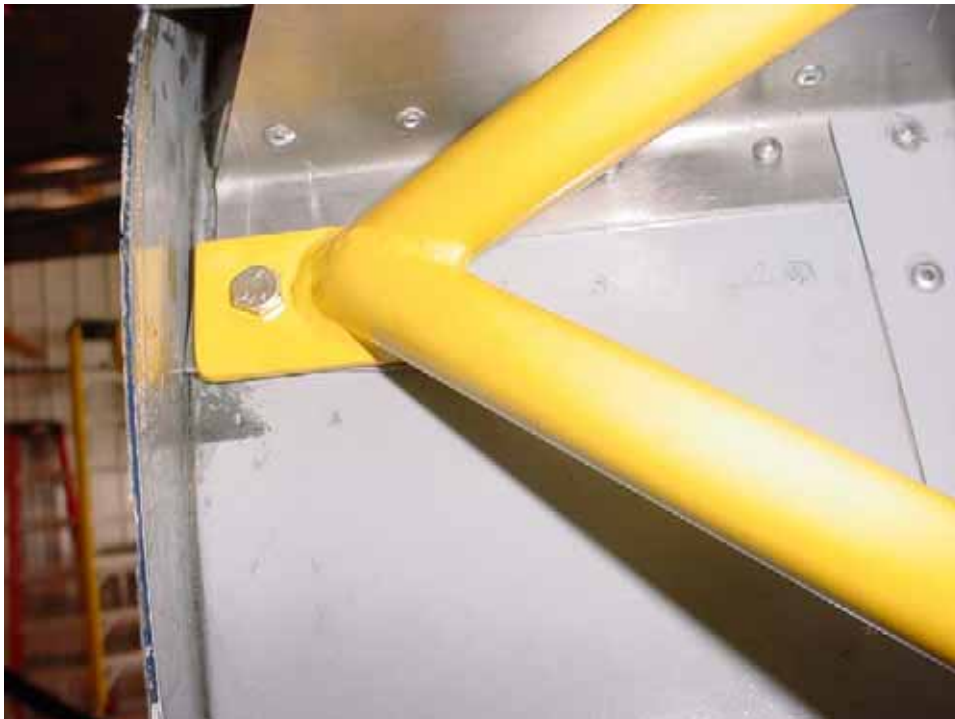

Right upper attachment.

AN3-6A

Shim on left and right side.



AN3-6A
Middle bolt through Steel angle 7F14-5R.



AN3-5A
Cabin side of firewall, lower engine mount bolted to firewall.



IMPORTANT: Bottom bolt is through the front bottom longerons 7F10-3, check for proper edge distance. Install bolt with the head inside the cabin.



Right lower attachment.

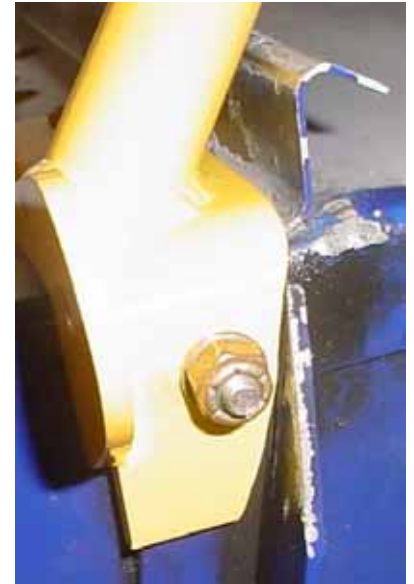

AN3-6A
Bottom view: right side.



Left lower attachment

COMMENT: Drill and cleco the engine mount to the firewall with pilot holes.



AN3-6A
Bottom view: left side.

OIL RESERVOIR



Position the oil reservoir on the left side of the firewall on the inboard side of the engine mount.

HEIGHT: The neck on the tank is held in place with a hose clamp riveted to the front flange of the upper channel 7F7-1SP.



Oil reservoir.



Allow approximately 5mm spacing between the side of the tank and the engine mount.



7E3-2R Oil tank side brackets
1L + 1R req.

Oil tank top bracket
1 required.



4 rivets 4A top plate to side bracket.



5 rivets A4 through firewall
Note: top rivets are pulled from the cabin side.

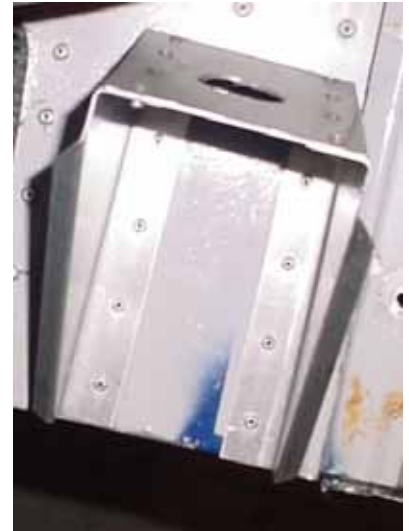
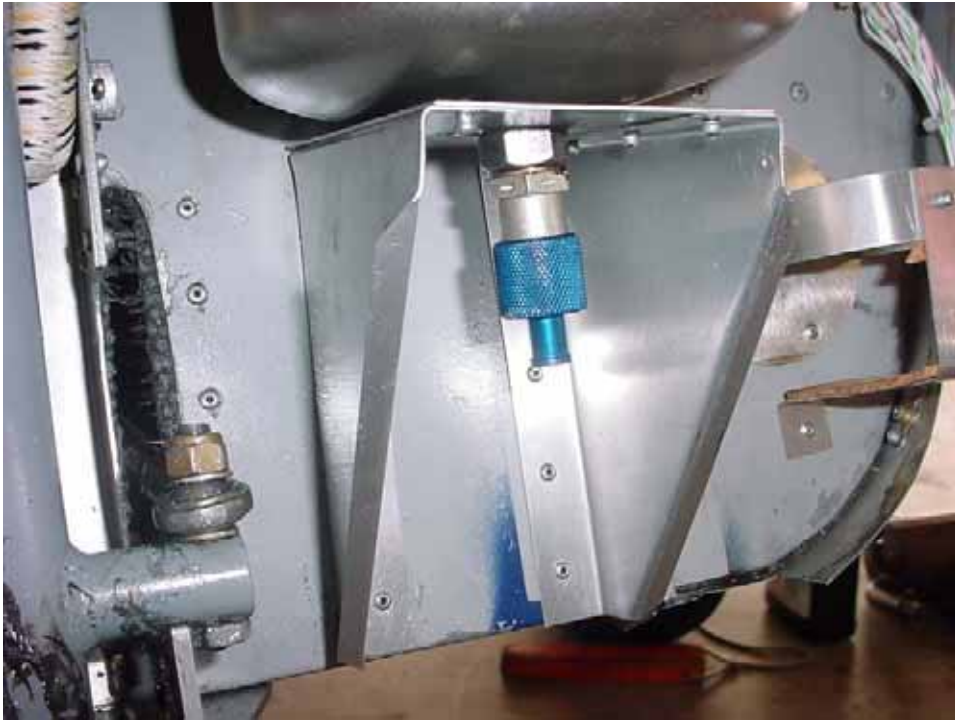

Rivet the top bracket to the side brackets.



Rivet the side brackets to the firewall.



Remove the engine mount to finish the installation of the brackets.



Cut a hose clamp in half.
Pre-drill 2 holes in the stainless steel – replace the drill bit after drilling through the stainless steel.

2 rivets A5.

THROTTLE



Throttle Bell Crank 7E5-1

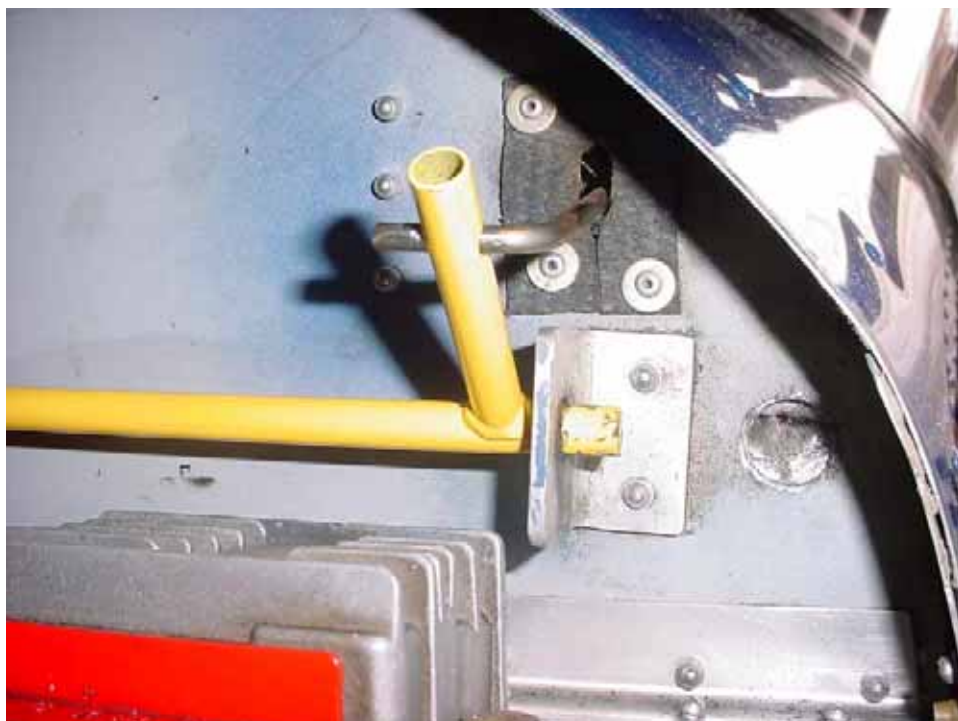

Detail of left side.



Check there is no interference with the engine mount.
 Line up the throttle cable stop 7E5-3 across from the throttle bell crank 7E5-1 (the vertical arms for the throttle cable). With the throttle in the full open (forward) the AN3 bolt is in line with the cable adjusters.



Corner reinforcement bracket 7E5-3 with 7F7-1SP.



Replace the cable adjusters on the carburetor with the cable stop adjusters 25-0700 (first re-drill the hole).

Throttle installation; refer to section 1B and drawing 7-E-5.



Throttle cables through 1/16" holes in AN3 bolts (holes are not supplied pre-drilled in the bolt).